

Manual Evobike Balance



- 1、 Preface
- 2、 Main technical parameters of electric vehicles
- 3、 Main technical parameters of the battery
- 4、 Main technical parameters of the motor
- 5、 Main technical parameters of the controller
- 6、 packaging
- 7、 shakedown test
- 8、 Safety and maintenance
 - 8.1 Safety advice

8.2 Maintain



Please pay attention

- 1、 Before riding, please read the Product Operation Manual carefully and check whether the parts are in good condition to ensure your riding safety. If you find any problem, please contact the dealer in time.
- 2、 Please abide by the urban traffic regulations, do not take people or drive on the road; slow rain and snow days and slippery areas, and increase the braking distance to ensure safety.
- 3、 The car is not afraid of rain, snow weather, but can not wade, when the water level flooded to the rear wheel motor hub, will cause the vehicle internal circuit short circuit and damage to the electrical

appliances, please pay attention!

- 4、 Do not disassemble the decomposed parts by yourself. If you need replacement, please purchase standard parts from the general agent of our electric scooter.
- 5、 For the safety of others, please do not lend your electric scooter to someone who can not operate to ride, and thus also protect your car from unnecessary damage.

Confident words to the user

Thank you for your wise choice, and for adding a new member to the electric car family. In order to you can easily use, but also for you can ride more safely, we specially compiled this manual. I hope that she can help you to have a detailed understanding of the electric sliding scooter, but also hope that she can give you a warm care.

This electric sliding step car has a unique shape, with its advanced and reliable design technology, to fasten the user's after-sales service, has established a good image in the domestic and foreign markets. The car body structure of 100,000 vibration can withstand, shock absorber device, high efficiency motor-and its drive system have become the leading and unique advantage of the electric vehicle.

User needs, it is our pursuit.

I hope you can tell us the feelings, thoughts and opinions of the future journey without reservation, and constantly promote our work to make our electric car products more perfect.

May we can provide you with a brand new service.

Main technical parameters of electric vehicles

2、Main technical parameters of electric sliding vehicle

2-1、Vehicle weight: $\leq 15\text{kg}$

2-2、dead weight : $\leq 60\text{kg}$

2-3、The highest speed: 20km/h

2-4、Continuation mileage: $10\sim 15\text{km}$ (60Kg at 20 Km/h on flat open surface, Ride without interruption)

2-5、Climbing capacity: $\leq 30^\circ$ slope

2-6、power rating : $\leq 250\text{w}$

2-7、Tire tire pressure: $\leq 35\text{--}55\text{psi}$

3、Main technical parameters of the battery

	Battery (Maintenance-free)
volume	5.2Ah
rated operational voltage	24v
Charging time	3-4h

4、Main technical parameters of the motor

	24VGear brushless motor
Rated output power	250W
rated voltage	24V
rated current	20A

electric efficiency	$\geq 80\%$
---------------------	-------------

5、 Main technical parameters of the controller

	24V controller
Under-pressure protection value	$20.5V \pm 0.5V$
Overflow protection value	$20A \pm 1A$

6、 packaging

6-1、 Install the handlebars.

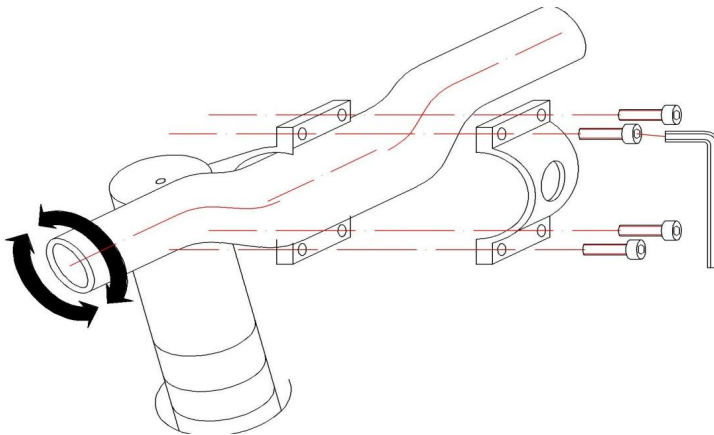

6-2、 Install front wheels. (Note: 1. The installation sequence of the wheel axle sleeve and gasket is shown in the figure below. 2. The side of the wheel with 6 threads is on the same side as the disc brake plate installed later.)



6-3、Down-to-earth installation.

Two cylindrical feet, one foot is the open hole, one is M10 thread, from the open hole of the screw through the frame under the position of the other threaded foot rotation tightly fixed.



7、shakedown test

7-1、Mad height debugging.

Release the saddle tube hug hoop, press and pull the saddle to the appropriate height (note that no safety line is exposed), clamp the hug hoop, and confirm that the cushion will not move before riding it.

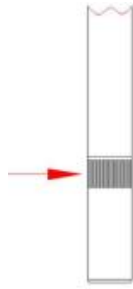



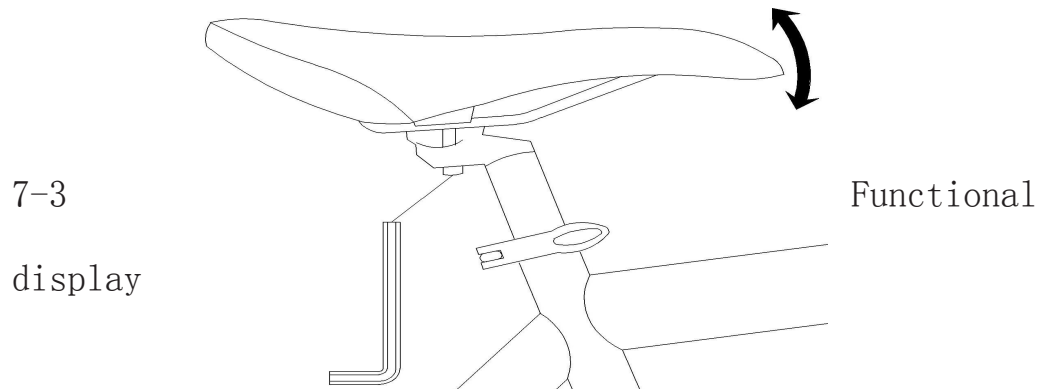



7-2、Pat angle adjustment.



1、Long press () : Open / close.

2、Short press () : Replacement mileage display.

3、There are 3 gears, “1-2-3” Short press () The button reduces or increases gears. ECO is low gear , MID is Medium speed gears , HIGH is high gear.

4、Long press () + () Go to the setting parameter interface, press () Replace parameter items, press () Parameter plus 1, press () Parameter minus 1.

Set the value:	P01: 8	P02: 0	P03: 24	P12: 2	P13: 01	P14: 3	
	P04: 10	P05: 5	P06: 10	P07: 15	P15: 08	P16: 12	P17: 20.0
	P08: 16	P09: 90	P10: 100	P11: 0	P19: 0	P20: 1	P26: 20.0



WARNING:Instrument parameters are strictly prohibited to change, otherwise it will lead to the wrong starting mode, speed display!!

8、Safety and maintenance

8.1Safety advice

8.1.1Do not charge around flammable or dangerous areas. Keep away from children when charging to avoid danger.

8.1.2.Discharge temperature ranges from-20°C to 50°C.

--Avoid rain soaking in batteries and motors when riding, which may cause danger.

lay in:

--- -Battery ambient temperature: 15 ~ 35°C ambient relative humidity: 75% RH. The battery shall be kept in a clean and dry placeAnd in the ventilation environment. Contact with corrosive substances shall be avoided and away from overheating and open fires

--The battery shall maintain a 70% capacity. The battery

should not be stored for more than 30 days.

--Lithium-ion batteries will decline in storage capacity

—The battery should be charged every 30 days for about 2 hours each time

—The battery shall have fire prevention measures when being stored together. There should be a safe distance or reinforced material isolation battery.

--Speed up slowly when starting your ride. Avoid static start, avoid sudden acceleration when starting, try to use both feet to assist the start, avoid static start when going uphill, it is best to use both feet to assist the uphill.

--Do not let the battery charge unattended.

--Your battery must be charged at 40 ° ambient temperature, on a non-flammable and dry surface, away from any source of heat, moisture or flammable sources

Here are the steps to charge the battery:

1、insert the charging head into the battery charging port.

2、Insert the charger power plug into the socket.

The LED indicator of the charger is illuminated as follows:

- Red or orange LED lights illuminate:The battery is charging.
- The red or orange LED light turns green:Battery charge full.

— should use bike helmets and knee pads.

--Check the tire wear regularly and check the tire pressure

at least once a month.

--Tire pressure: 35-55psi, depending on the user's weight.
Please care and clearly state any risk of rim wear.

Check all the connections to the disc brakes before trying to ride. Tighten 6 bolts and 2 bolts fixing the plate to the rear hub

Note: The maintenance and repair of electric vehicles requires specific skills and appropriate tools. Do not repair your electric vehicle or change any settings, please contact your dealer. Any improper adjustment or repair may damage the electric vehicle and cause accidents causing extensive injuries. Use only real replacement parts for safety-critical parts. When cleaning, we must pay attention to the water leakage from the front section of the protective coil of the frame, resulting in a short circuit. Use soapy water or water mixed with mild detergent and then rinse with clean water. Do not use a high-pressure washer!

8.2 Maintain

Your electric balance bike is very safe for the environment. Used parts must be disposed in the appropriate classification recycling bin. The battery can no longer be used and returned to your dealer so that he can transfer it to the recycling company.

Motor: The motor does not require any maintenance.

Information and warranty coverage on electric scooters are available from your dealer. When your electric scooter leaves the factory, your dealer will also give you a warranty policy

parameter list:

Motor type& TRANSMISSION	
Motor type	250w Gear brushless motor
Gearbox / Speed Mode	3 Speed (9-17-20km/h)
Starter	Throttle / Kick (Kick can be turned on/off)
Running Time	1.5-2 Hours
Charge Time	3-4 Hours
Final Drive	Rear wheel motor drive (No Chain)
Top Speed	20 km/h
Battery	Lithium battery 24V 5.2Ah
SUSPENSION, BRAKES, & WHEELS	
Brakes Rear	Disc Brake
Wheel & Tire Front	16-2.126
Wheel & Tire Rear	16-2.126
Tyre	Inflatable tire
DIMENSIONS & WEIGHT	
Wheelbase (axle to axle)	780mm
Seat Height	480mm + 100mm
Product Weight N.W G.W	12.8 / 14.8
Max Load	75 Kg
Product Packing Size	101x24x56CM

